

Article number: 03466008
 Description: Fluro Rod end EA 8D
 Note: 8

Measures

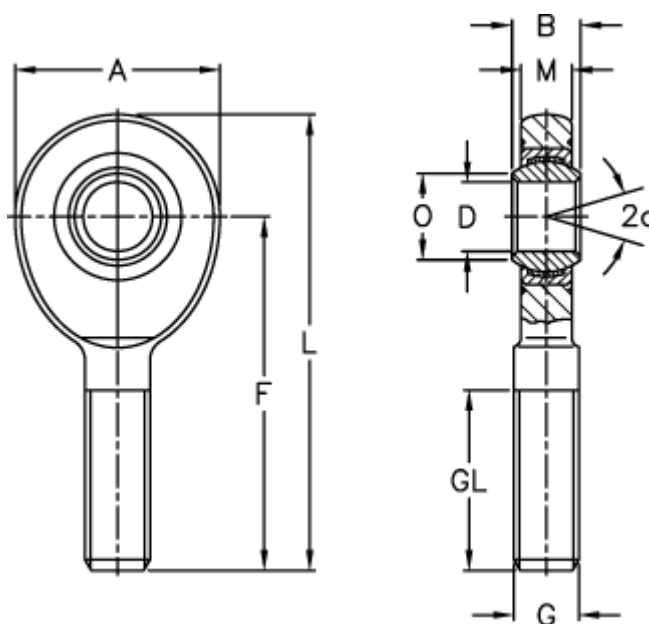

A	= 24	L	= 54
a (degrees)	= 15	M	= 6
B	= 8	O	= 10.2
D	= 8	Static drive kN	= 12.7
Dynamic drive (kN)	= 5.8	Weight	= 28
F	= 42		
g	= M 8		
GL	= 22		